

P200

Power Packer



The P200 Power Packer is the Ideal Solution For:

- Manufacturing Facilities
- Industrial Applications
- Distribution Centers
- Restaurants
- Hospitals
- Hotels
- Convenience Stores

The innovative way to reduce hauling costs and get rid of unsightly trash and the space required for trash storage.

Compare these features of the P200 with the competition:

- Available with front load and rear load containers
- 7½ to 1 compaction ratio
- Our P200 is designed to reduce trash storage and pick-up expense
- Fast 42 second cycle time
- The unique counter-balanced loading door is easy to open
- Safety switches disable the machine when the loading door is open, preventing injury

- Key lock controls prevent unsafe, unauthorized operation
- Compaction pressure is held until the next time you need to load, the end result is more room to load more solid waste
- Our P200 can also be supplied with a feed chute giving increasing flexibility in loading and site location
- Dual cylinders produce 21,200 lbs. of maximum ram pressure
- 3" twin cylinders

The P200 Power Packer, another great idea from Harmony Enterprises... *The Undisputed Leader in Quality Manufacturing.*



P200 Power Packer



Container Support System

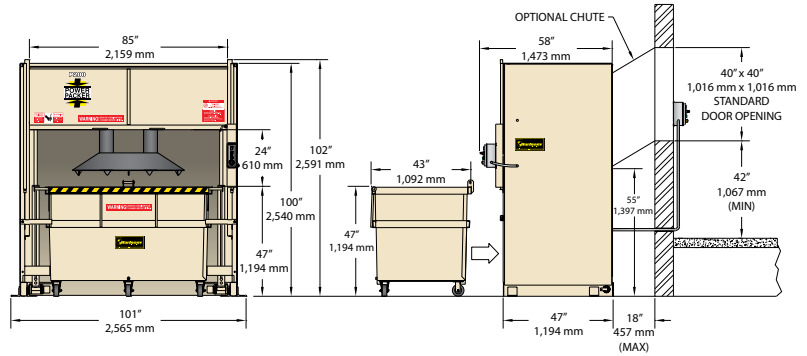

Standard P200 Features:

- All controls are UL® listed
- When the compaction plate begins its downward pressure against the waste material the Container Support System pushes upward to relieve stress on the floor and the casters of the container
- The Power Packers two-yard container is available in either a front loading or rear loading version
- Heavy-duty motor and hydraulics for extra long life
- Optional Air Sanitizer eliminates odor problems
- Meets or exceeds all ANSI and OSHA safety standards

SPECIFICATIONS

Container Capacity	2 cubic yards
Ram Pressure	21,200 lbs. maximum (9,616 kg)
Cycle Time	42 seconds
Twin Cylinders	3" bore (76 mm) 1.5" rod (38 mm) 37.5" stroke (953 mm)
Motor	2 horsepower, TEFC
Pump	Two-stage
Electrical Power	115/230 volt, 1 phase, 60 hz

DIMENSIONS

Loading Door Opening	85" x 24" (2,159 mm x 610 mm)
Container Height	47" (1,194 mm)
Overall Height	102" (2,591 mm)
Overall Width	101" (2,565 mm)
Overall Depth	58" (1,473 mm)
Load Opening	85" x 24" (2,159 mm x 610 mm)
Ram Face	48" x 27" (1,219 mm x 686 mm)
Oil Reservoir	6 gallons
Shipping Weight	
- Compactor	3,250 lbs. (1,474 kg)
- Container	734 lbs. (333 kg)

Specifications subject to change without notice.



SAI GLOBAL
ISO 9001
Quality

Harmony Enterprises, Inc. 704 Main Avenue North Harmony, MN 55939 USA
1.800.658.2320 toll free | 1.507.886.6666 international | 1.507.886.6706 fax
Email us at info@harmony1.com or visit us online at www.harmony1.com

©2019 Harmony Enterprises, Inc. All rights reserved. Form HEI_P200_US 07/09 SC